

NBS-2301P26

Multi-Zone Network Mixer Amplifier



SPON Multi-Zone IP paging amplifier NBS-2301P26 provides multiple external audio interface to meet any application scene ,such as supermarket、 office building 、 school ,etc . Integrated with pre-amplifier function , bass and treble controls are provided to adjust the sound effect and volume of each audio channel . Automatic cooling system ensures the extreme quite sound system . This amplifier can be called as 4 zone audio amplifier.

4 channels

Network
IntercomRemote
Broadcasting

MAIN FEATURES

Design & Interface

- Durable 2U rack design with a 4.3-inch TFT color LCD screen and control knob.
- Infrared remote control compatibility and multiple status indicator lights for easy maintenance.



Powerful Audio Control & Protection

- Integrated digital Class-D 260W amplifier compatible with 100V and 8-16 Ω loudspeakers.
- Comprehensive protection circuitry against overload and overheating.
- Four independently controlled output zones for targeted broadcasting

Built-in Features & Connectivity

- Internal clock chip for server-independent timed broadcasting, with programs uploaded to a local SD card.
- Built-in microphone and speaker enabling two-way intercom functionality.
- Relay I/O port for integration with third-party fire alarm systems.

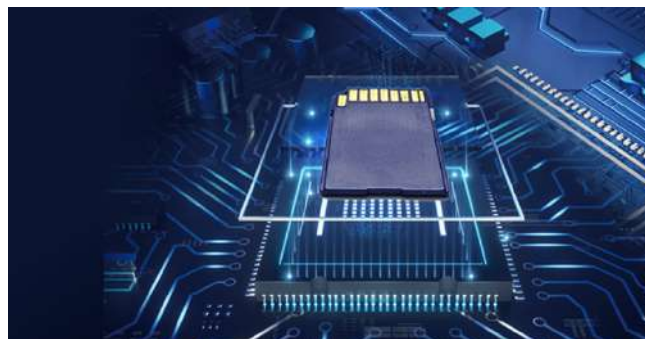

SPECIFICATION

Power Parameters

Power Supply: AC 220V, 50Hz

Rated Output: 260W

Power Consumption: ≤320W

Audio Parameters

Audio Codec: MP2, MP3, PCM, ADPCM

S/N (Signal-to-Noise) Ratio: Mic Input 01: ≥65dB;
Mic Input 02/03: ≥80dB;
Aux Input 01/02: ≥82dB;

Audio Sampling & Bit Rate: 8kHz~44.1kHz, 16bit,
8kbps~320kbps

THD (Total Harmonic Distortion): ≤0.5% at 1kHz, 1/2 rated output

Frequency Response: Mic Input 01: 80Hz~14kHz;
Mic Input 02/03: 60Hz~16kHz;
Aux Input 01/02: 60Hz~16kHz;

Network Parameters

Network I/F: 10BASE-T/100BASE-TX RJ45

Network Protocol: HTTP, TCP/IP, UDP, ARP,
ICMP, IGMP

Configuration Method: Web Interface or DevConfig Tool

Accessories

2×6-Pin Pluggable Terminal Block Connector
(3.81mm Pitch, AWG 26-16)

4×Flat Head Screw & Washer

1×Quick Installation Guide

1×Quality Certificate&Warranty Card

1×Power Cord

Compliance

CE (EMC Directive 2014/30/EU)

CE (LVD Directive 2014/35/EU)

Mechanical&Environment Properties

Mounting Method: 2U Rack-Mounted

Installation Environment: Dry Indoor Locations Only

Operating Temperature: -10°C~+50°C (14°F~122°F)

Operating Humidity: ≤90% RH non-condensing

Heat Dissipation: Automatic start of the built-in fan when the temperature of the radiator exceeds 55°C, forced air cooling from front to back.

Protection: Over-Current Protection, Short-Circuit Protection, Overload Protection, Thermal Protection

Front Panel Material: Aluminum Alloy

Housing Material: Surface-Treated Steel Plate

Color: Black

Product Dimensions: 483×430×88mm

Product Weight: 7.5KG

Packaging: Carton Box

Packed Dimensions: 560×530×170mm

Packed Weight: 9.5KG

Product Warranty: 2 Years Limited

PORTS DESCRIPTION

[Front Panel]

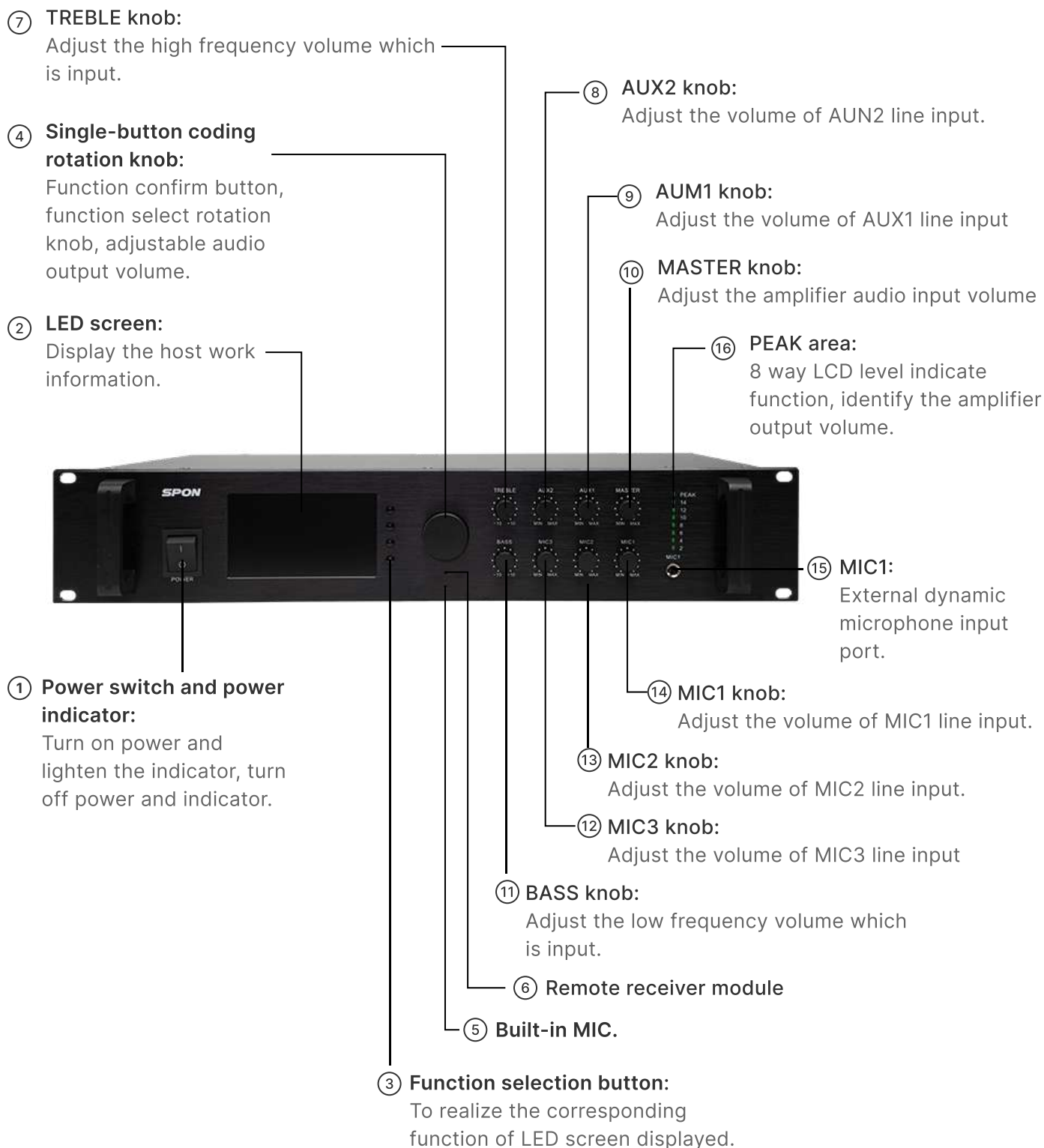

PORTS DESCRIPTION

[Rear Panel]

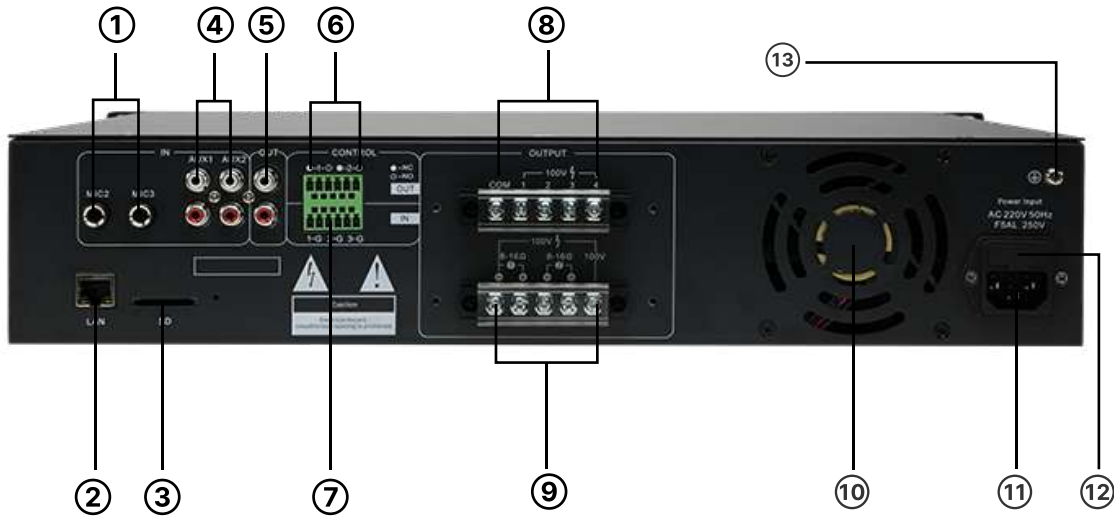

① MIC 2、MIC 3:
External condenser microphone.

② Network input port :
To connect with Ethernet switch

③ SD card insert port :
To storage timed task file.

④ AUX 1、AUX 2 Line input port :
To connect to external audio sources equipment.

⑤ AUX Line output port :
To connect to legacy amplifier with impedance 600Ω-10kΩ.

⑥ Relay output 01/02 port :
3-Pin Pluggable Terminal Block (3.81mm Pitch, AWG 26-16), Normally Open (NO) or Normally Closed (NC) Dry Contact .

⑦ Relay input 01/02/03 port:
2-Pin Pluggable Terminal Block (3.81mm Pitch, AWG 26-16), Normally Open (NO) Dry Contact

⑧ Multi-Zone Speaker Output (100V)port :
5-Pin Screw Terminal Block, connecting and driving 100V constant-voltage passive speakers with zoning options .

⑨ Speaker Output (100V、8Ω~16Ω) port :
2-Pin Screw Terminal Block, connecting and driving 100V constant-voltage passive speakers ; 2-Pin Screw Terminal Block, connecting and driving 8Ω constant-resistance passive speakers (total impedance between 8Ω~16Ω).

⑩ Cooling fan

⑪ AC220V power input port

⑫ Fuse

⑬ GND

CONNECTION DIAGRAM

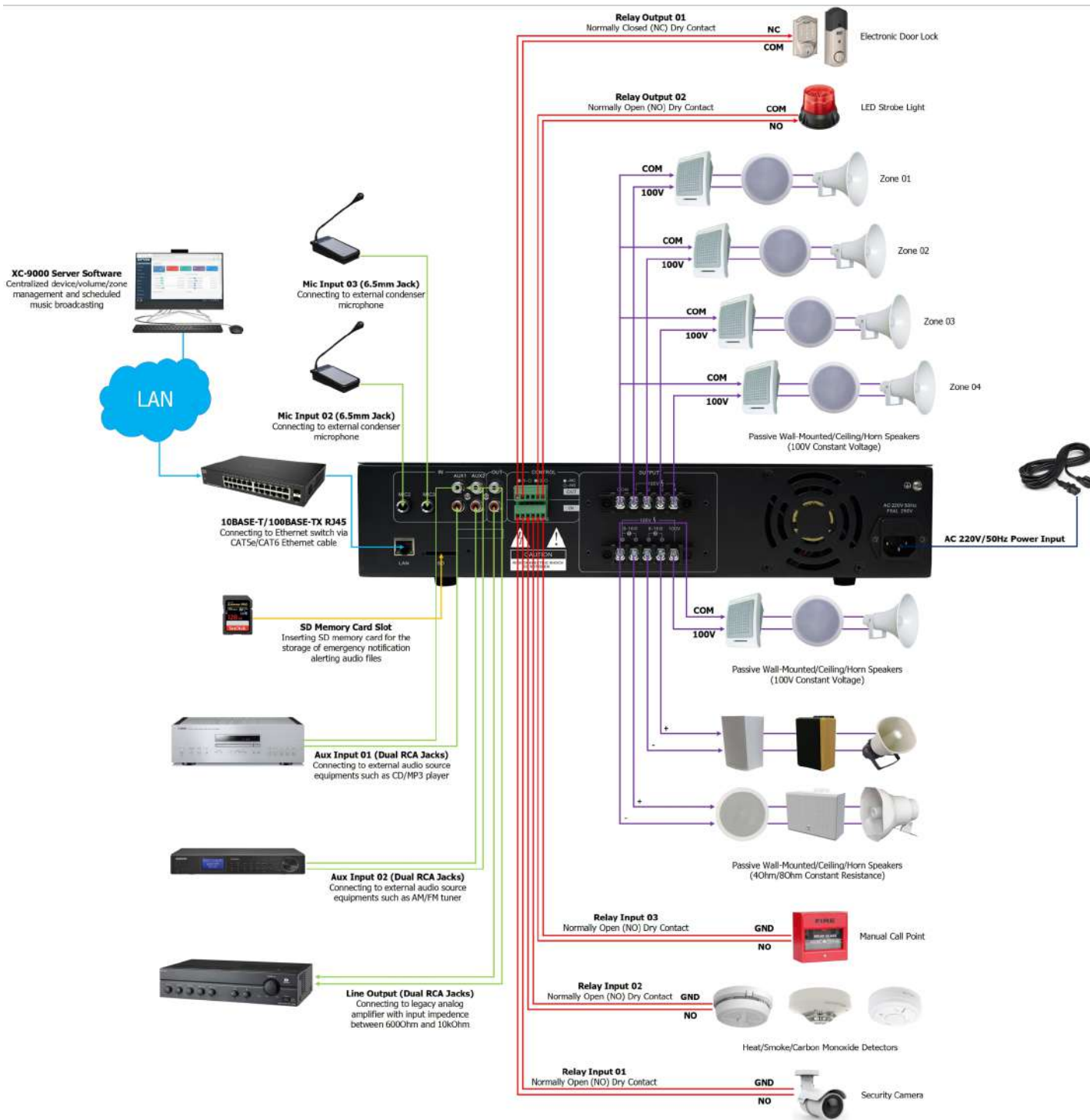

APPLICATION

Application 1

The Multi-zone IP mixer amplifier NBS-2301P26 can receive real-time voice announcement initiated by the 3-rd party VOIP telephone、SPON IP paging microhone/APP(Windows、Android/IOS),etc. With built-in amplifier and line output interface, the voice can be transmitted to external passive speaker for amlification.

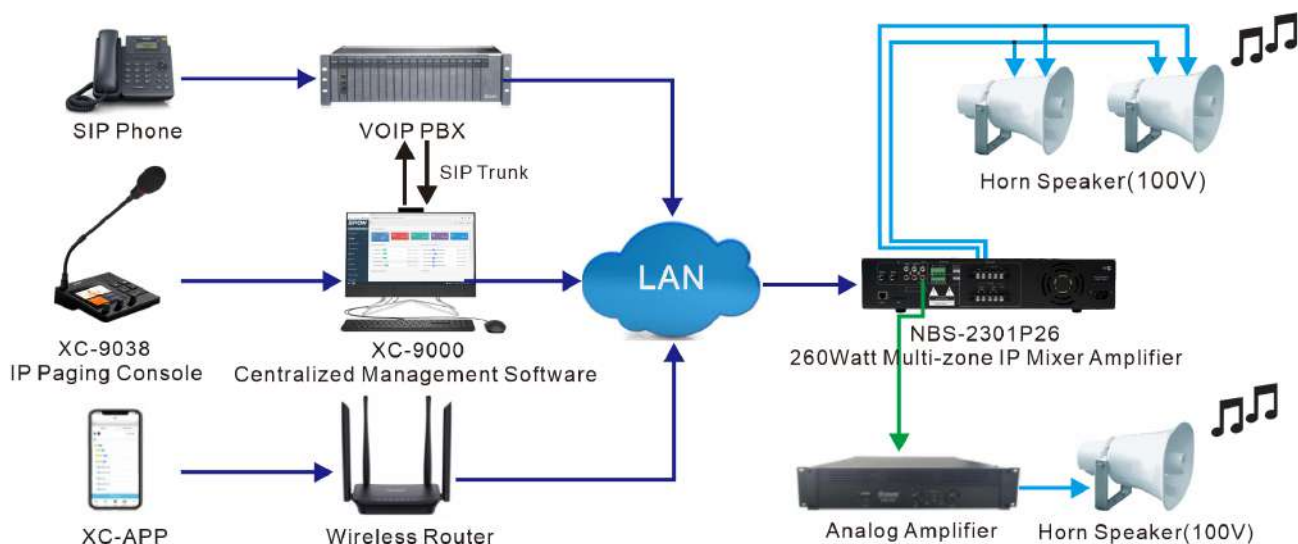

Application 2

The Multi-zone IP mixer amplifier NBS-2301P26 support offline timed broadcasting , the offline timed program need to be pre-uploaded on SD card of the amplifier, when the windwos crashed , the system can normally work.

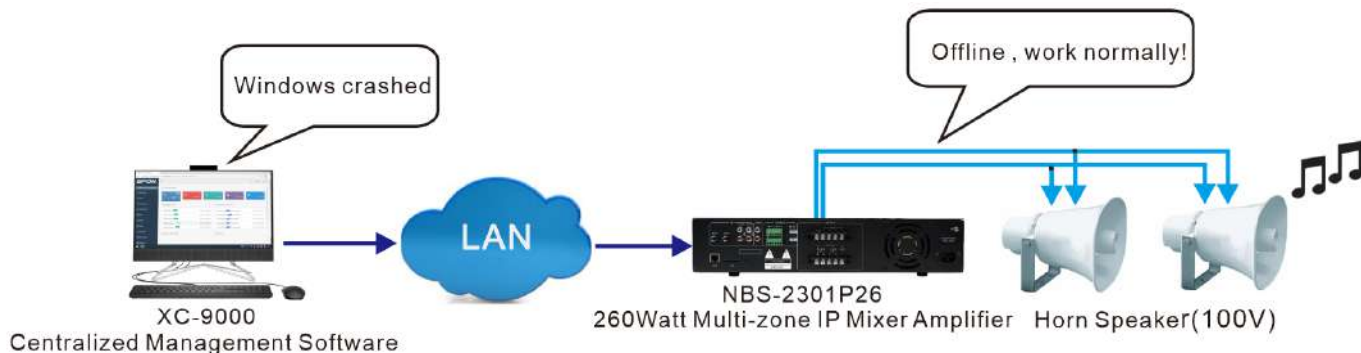

APPLICATION

Application 3

The Multi-zone IP mixer amplifier NBS-2301P26 support to automatic broadcast alarm tone when receiving relay input signal from the 3-rd party system (For example ,IP camera of surveillance system 、 Emergence button of Fire alarm system) , the alarm tone need to be pre-set on schedule task of XC-9000 software.

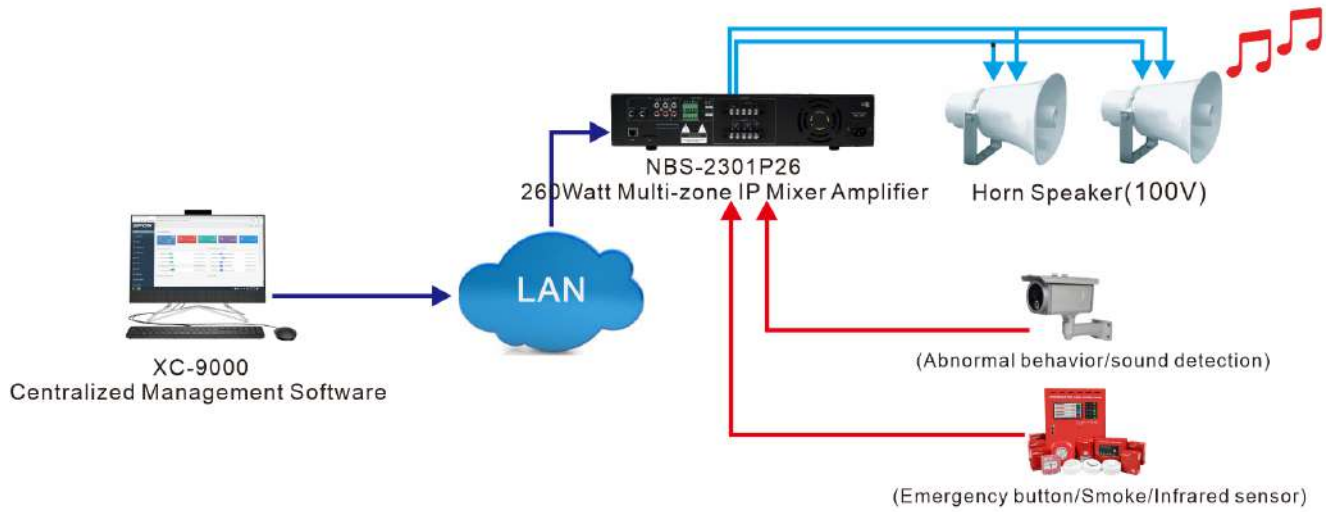

DIMENSION DRAWING

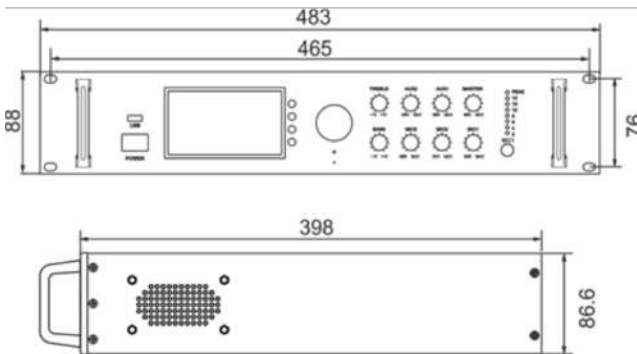

Multi-zone IP amplifier NBS-2301 in rack-mounted installation with 4pcs of white washers head screws (M3*5). Please refer to the following dimension diagram to put device in suitable cabinet.

CASE



SPON SPON Communications Co., LTD

Address: No.70, Nantang Road, High-Tech Zone, Changsha, China.

Mobile: +86 138 7314 3517

Email: inquiry@sponcomm.com **Tel:** +86 731 8557 0190



www.sponcomm.com