

SPON

WALL SPEAKER Installation Manual



1.Summary

Wall Speaker is a 30W wall-mounted speaker with exquisite appearance, simple structure and very convenient installation. While providing high-quality sound quality, it can meet the decoration requirements of various use occasions. It is suitable for playing voice and music in shopping malls, schools, meeting rooms, hotels and restaurants.

2.Features

Superb audio and music reproduction performance

High-strength HIPS material

Lower maintenance cost

Quick and easy installation

CE complia

3.Technical Specifications

Electrical	
Max Power	45W
Rated Power	30W
Power Tapping(100V)	3.75W/7.5W/15W/30W
Power Tapping(70V)	1.9W/3.75W/7.5W/15W/30W
Constant resistance(8Ω)	30W
Sensitivity(1m/1W)	86dB
S.P.L(1m/20W)	101dB
Frequency Response	90Hz ~ 18kHz
Dispersion Angle(1kHz / -6dB)	115°
Rated Input Voltage	100V/70V
Rated Impedance(100V)	2.7kΩ /1.3kΩ /667Ω /33
Rated Impedance(70V)	2.7kΩ /1.3kΩ /667Ω /333Ω /167Ω
Connection	Terminal
Mechanical	
Dimensions	184 x 249 x 165mm
Panel and back shell	HIPS
Grille	Powder Coated Iron Mesh

Color	White
Product Weight	2.54kg
Speaker size	5"woofer+1"tweeter
Environmental	
Operating Temperature	-25°C to +55°C
Storage Temperature	-40°C to +70°C
Relative Humidity	<95%

4. Three View

Unit: mm

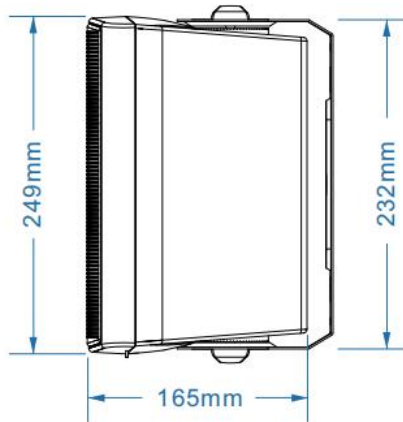
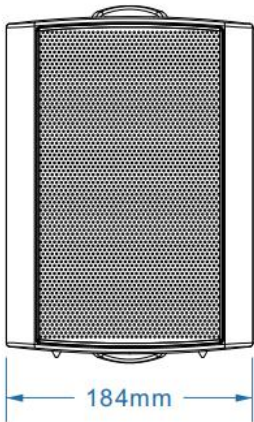
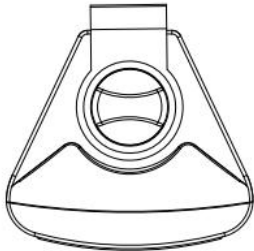

5.Circuit Diagram

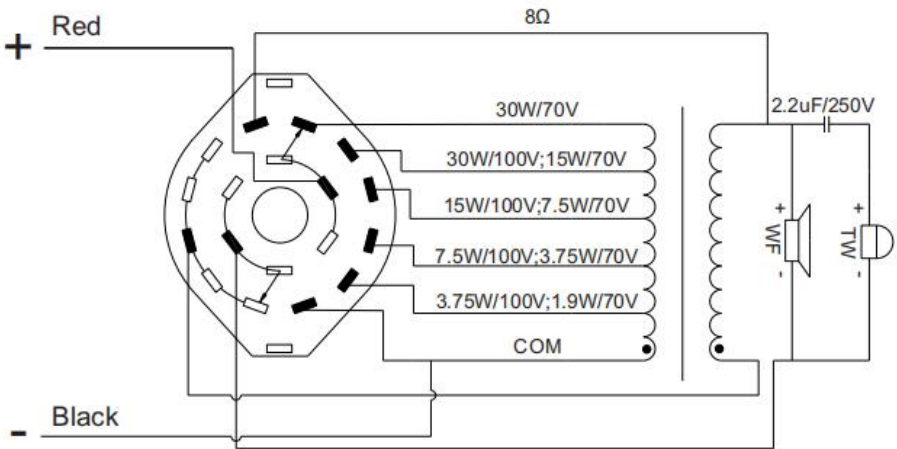

6.Installation Instructions

(1) First pierce two mounting holes suitable for Φ6mm expansion rubber plugs on the wall, the distance between the holes is 144mm, and put Φ6mm expansion rubber plugs.

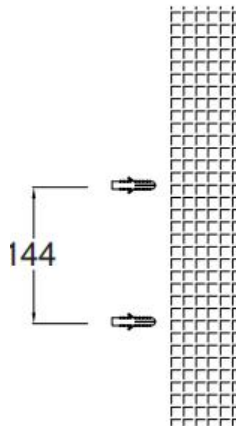

(2) Remove the product bracket, align it with the pre-made expansion rubber plug on the wall, lock the ST4.0 self tapping screw, and fix the bracket on the wall.

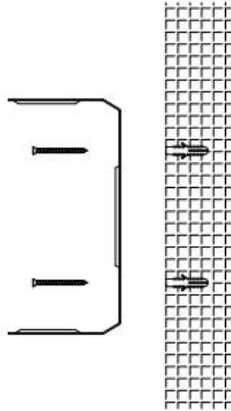

(3) Connect the audio cable, and then fix the product on the bracket.

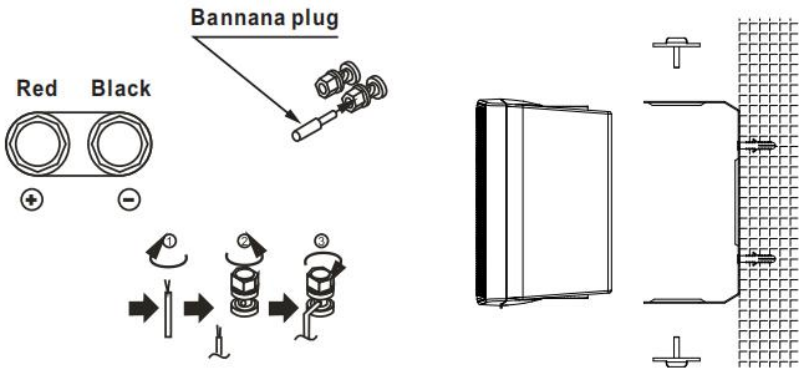

(4) Then adjust the required angle of the speaker.

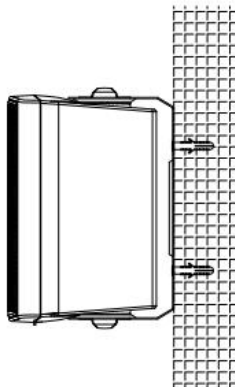

7.Packing list

- (1) Wall Speaker 1pcs
- (2) Installation Manual 1pcs
- (3) Certificate 1pcs



 Wechat

SPON Communications Co., Ltd.
www.sponcomm.com
Service Hotline: +86-731-85570190
Reserve the amendment right without notice



V1.0B240304